

Air Scrubber

MOBILE BY AERUS

WITH CERTIFIED SPACE TECHNOLOGY™

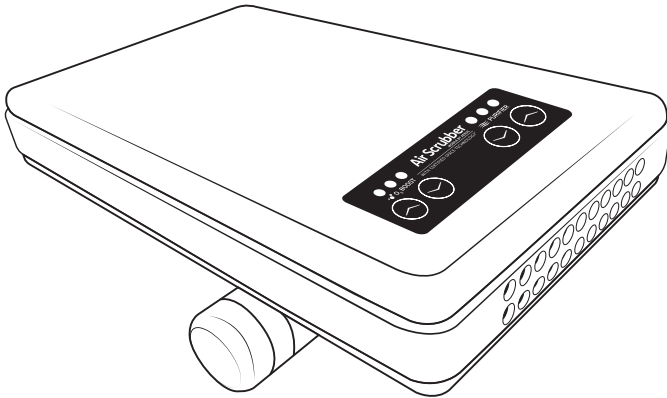

Portable Electronic Air Purifier

CAUTION: READ MANUAL CAREFULLY FOR PROPER PROCEDURES AND OPERATION



TABLE OF CONTENTS

Specifications	2	Power Adapters	5
Control Pad Layout	2	12VDC Adapter Fuse	5
Parts and Accessories	3	Portability	5
Operation	3	Disassembly	5
Mounting the Base	4	Assembly	6
Adjusting the Wire Stand	4	Maintenance	6
Wire Stand Positions	4	Cleaning	6
Effects of High or Low Voltages	4	Troubleshooting	6
		Warranty	7

SPECIFICATIONS

Power Usage2 VDC; 10 Watts
Technology	Needlepoint ionization, ActivePure® Cell, Activated Oxygen
Max Activated Oxygen	0.05 ppm (ambient), 1.75 ppm max
Size	3.625"W x 1.0"H 6.0"D (without base)
Weight8 oz.
Coverage	500 sq. ft

CONTROL PAD LAYOUT

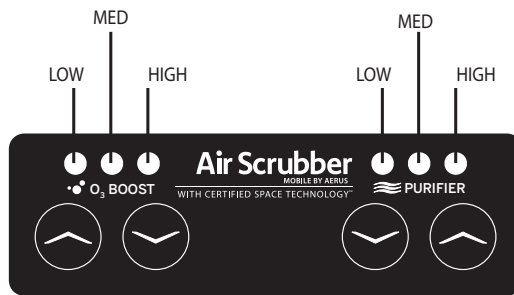

WARNING: UV Lamp operation. Do not operate this unit unless the case is completely and correctly assembled. Failure to comply may result in serious eye damage.



CAUTION: Use O₃ Boost in accordance with directions found in this manual only.



CAUTION: Disconnect power cord before servicing.

PARTS AND ACCESSORIES

A. WIRE STAND	9950153
B. BASE.....	9950154
C. KNOB/CLAMP PANK (2).....	9950155
D. 12VDC ADAPTER.....	9950157
E. 2.0 AMPUSE.....	9950162
F. AC ADAPTER.....	9950158
G. SERVICE KIT.....	9950209

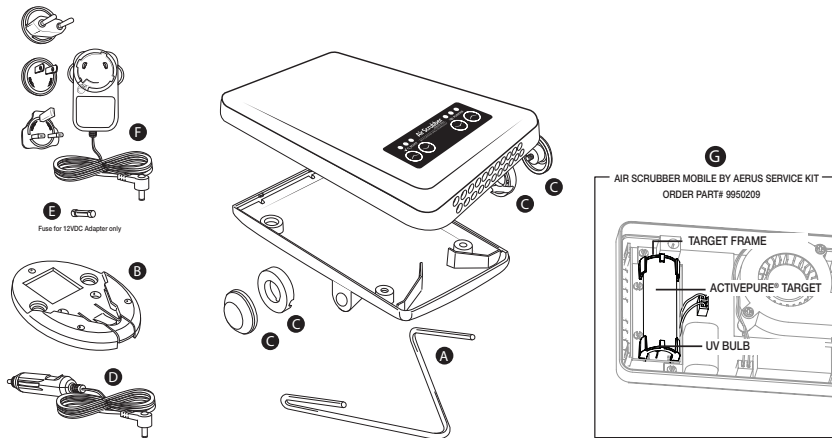

OPERATION

1. If desired, mount the base in an appropriate location (see below).
2. Adjust the wire stand (see page 4).
3. Plug in either the 12VDC car adapter or the AC adapter.
4. The Air Scrubber Mobile by Aerus unit will come on when power is supplied to the unit.
5. Adjust the Purifier by pressing the Purifier UP and Purifier DOWN buttons. When the unit is off, all the LED lights will also be off.
6. Set the O₃ Boost by pressing the O₃ Boost UP and O₃ Boost DOWN buttons. See the Settings chart (below) for proper adjustments. When the O₃ Boost is set to off, the LEDs will also be off; the Purifier LED(s) will remain on. Do not exceed recommended settings.

LEDs	Setting	Coverage
● ● ☀	Low:	Compact Car, Pickup
● ☀ ☀	Med:	Large Sedan, SUV, or Semi-Cab
☀ ☀ ☀	High:	RV/Motor Home or Houseboat
● ● ●	OFF:	Purifier Off: ionization & fan may continue operating if desired.

MOUNTING THE BASE

The base for the Air Scrubber Mobile by Aerus can be mounted using the included suction cups, Velcro, or screws, depending on preference. When using suction cups or Velcro, be sure the surface is smooth and clean. Dirt, grease, protectants, and other substances will affect performance and holding ability.

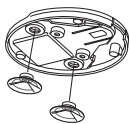

- Attach suction cups by pressing and twisting into the base, or...

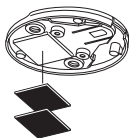

- Peel and stick one part of the Velcro to the base, then attach the other to a clean, dry surface, or...

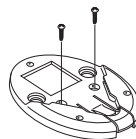

- Screws may be used for extra security and where the other methods are not appropriate.

ADJUSTING THE WIRE STAND

The wire stand on the Air Scrubber Mobile by Aerus allows for quick release from the base, provides a stand or hanger for the unit independent of the base, and allows the unit to either stand or hang from the base depending on how the base is mounted.

To adjust the wire stand, loosen the two knobs on the sides of the unit approximately 1/2 turn. The unit may then be tilted up or down to adjust the angle or moved on the wire stand to change the height. You can also remove and change the position of the wire stand to accommodate several different mounting methods. To reinstall, simply align the two clamp collars and insert the wire stand. Once the unit is adjusted, tighten both knobs to hold it in place.

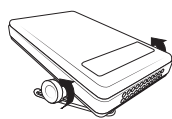

THEN



OR



WIRE STAND POSITIONS



- Sitting on a flat surface with or without the base
- Hanging over an edge pointing down (laundry hamper, garbage can, etc.)



- Sitting on a flat surface without the base
- On a vertical surface with the base (wall mount, window, etc.)
- Hanging over an edge pointing up (seat pocket in car)

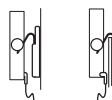
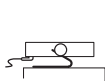
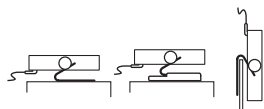

NOTE: Unit can be used without attaching the base or wire stand.

EFFECTS OF HIGH OR LOW VOLTAGES ON AIR SCRUBBER MOBILE BY AERUS WHEN USING THE 12VDC CAR ADAPTER

Air Scrubber Mobile by Aerus has an operating voltage range of 11 VDC to 14.6 VDC. If the voltage coming into the unit is too high, the unit may blow the 12VDC adapter fuse. This type of problem usually indicates something is wrong with a vehicle's electrical system. If the unit shuts down while using the 12VDC automotive adapter and you are unsure of the cause, check the adapter fuse. If the fuse is not blown, test the unit using the supplied AC adapter. Once the voltage problem (drained car battery, electrical system problem, etc.) is corrected by a qualified service person, you will be able to resume using your Air Scrubber Mobile by Aerus with the 12VDC adapter.

POWER ADAPTERS

⚠ CAUTION: Not for use on 12 volt positive ground or 24 volt vehicles. Doing so may damage the product.

Air Scrubber Mobile by Aerus comes with both a 12 volt DC car adapter and a 100 - 240 volt 50/60 Hz AC adapter with interchangeable plugs.

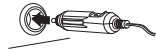

- Insert the car adapter into an appropriate 12 volt automotive type power outlet.

12VDC Adapter Fuse



To change the car adapter fuse, unscrew and remove the front of the adapter. Replace with the same type and rating only: 2 amp Buss type fuse (service part #9950162).

OR



- Select and install the proper international plug into the AC adapter. Insert correctly assembled adapter into a standard electrical outlet.

NOTE: when installing one of the interchangeable plugs, be sure to twist and lock it into place. When removing a plug, press the raised tab to release, then turn the plug out the top.

THEN



- Insert the small adapter plug into the opening located underneath at the rear of the unit.

PORTABILITY

- Depending on how it is mounted, your Air Scrubber Mobile by Aerus can be ready to take with you in just a few seconds.



- Once the unit is assembled and the base mounted, simply snap the wire stand into the base. The latch at the front of the base should snap into place, locking in the stand and unit.



- To remove the unit from an attached base, press down on the front latch and slide the unit back, then up.



- For added convenience, mount extra bases where you use your Air Scrubber Mobile by Aerus most. See your HVAC Independent Contractor for more information.

NOTE: If you prefer to remove the base and unit together, mount the base with Velcro or suction cups to a clean, dry surface.

DISASSEMBLY (FOR MAINTENANCE AND REPLACEMENT OF SERVICE KIT 9950209)

⚠ CAUTION: The unit must be disconnected from its power source before servicing, and should not have the power reconnected unless the case is correctly and completely reassembled.

All user maintainable parts of the Air Scrubber Mobile by Aerus are accessed by removing the lower half of the case.

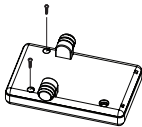

1. Turn unit over, tilt up slightly, and remove screws at the front of the unit.

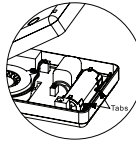

3. Lift the small circuit board holding the target screen and bulb (Bulb Assembly) from the two tabs.

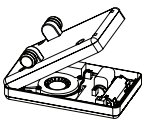

2. With the front remaining tilted up, slide the lower half of the case back and up until it is free.

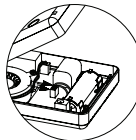

4. Disconnect the leads of the Bulb Assembly from the main circuit board.

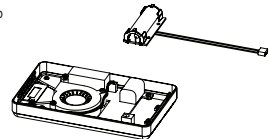

5. Remove the Bulb Assembly from the unit.

ASSEMBLY

Reinstallation is the reverse of the above steps:

- UV lamp – Do not touch with bare hands. If touched, clean the bulb with a cotton swab and a small amount of alcohol.
- Attach ActivePure® Target Screen (a) to the Target Frames (b).
- Install the legs of the Target Frames (b) into the four holes of the Bulb Assembly PC board (c).
- Attach the 3-pin connector (e) of the Bulb Assembly to the main unit PC board.
- Carefully align the two holes in the Bulb Assembly to the two tabs on the main unit.
- Press gently to install the Bulb Assembly.
- Carefully replace the bottom case, being sure the pins inside the back of the bottom case fit into the two standoffs at back of the top case. Slide the bottom case forward then down, making sure the wires are completely inside the case.
- Check for proper alignment before installing and tightening the screws. Failure to correctly assemble may cause damage to the case.
- Replace cover and two screws.

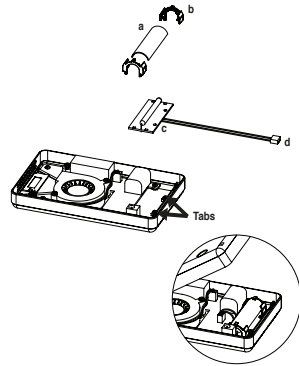

MAINTENANCE

A service kit is available for your Air Scrubber Mobile by Aerus. The kit contains a new ActivePure® Target, UV bulb, and ActivePure® Purification Plate. For optimum performance, we recommend replacing these components annually. See your Independent HVAC Contractor for more information.

CLEANING

Depending on conditions, your Air Scrubber Mobile by Aerus will require periodic cleaning of certain internal components every one to three months.

ActivePure® Target - Clean the target by gently removing dust with a small, soft brush.

UV Bulb - The UV bulb should be gently wiped with a soft, dry cloth. Avoid handling the UV bulb more than necessary.

ActivePure® Ozone Plate - The top area of the ActivePure® Purification Plate can be cleaned with ammonia or alcohol and a cotton swab. Do not use water. Allow to dry thoroughly.

Case - Clean the exterior case of your Air Scrubber Mobile by Aerus with a soft cloth dampened (not wet) with water. Do not use harsh chemicals or solvents.

Fan/Interior of unit - The interior and fan may be cleared of dust using canned air suitable for electronics.

NOTE: See pages 5 - 6 for detailed views of components

TROUBLESHOOTING

⚠ CAUTION: Under no circumstances should your Air Scrubber Mobile by Aerus unit be operated while any part of the case is damaged, missing, or disassembled. If the case is damaged, return your unit to Your Independent HVAC Contractor for repair or replacement. Direct exposure to the internal UV light may cause eye damage.

Unit does not operate/the O₃ Boost does not operate/all LEDs off

- Unplug and reinsert the adapter plug and adapter to check where the power supply is plugged in to be sure it has power.
- If using the 12VDC car adapter, remove the fuse by unscrewing the end of the adapter and check to see if it is blown. Replace it with the same type and rating fuse only (see Specifications). If the fuse is not blown, check the outlet for proper voltage.

UV bulb or O₃ Boost may not be working

- Press the PURIFIER UP or PURIFIER DOWN buttons to turn the Purifier function ON.
- If checking O₃ Boost operation, press the O₃ Boost UP button to turn the O₃ Boost ON.
- Remove the Bulb Assembly, clean, and reinstall (see Disassembly and Cleaning).
- If cleaning and reinstalling does not correct the problem, replace the Bulb Assembly (service kit #9950209).
- When looking through the rear inlet vents in low light you should see a slight bluish glow. If there is no glow, replace the Bulb Assembly (service kit #9950209).

Lack of air flow

- Make sure the intake vents are not blocked and the front of the unit is clear.
- Check to see if the fan is operating (if not, see above).

If your unit fails to operate properly after performing troubleshooting, contact your Independent HVAC Contractor for further assistance. You may also contact Customer Service at 866.736.0503, or visit www.AirScrubberByAerus.com for additional support.

WARRANTY INFORMATION

LIMITED 1 YEAR WARRANTY

Customer should not repackage and ship the Air Scrubber Mobile by Aerus unit due to possibility of irreparable damage. For warranty service, please contact your Independent HVAC Contractor or call Customer Service at 866-736-0503.

WHAT IS COVERED BY THIS WARRANTY

We warrant the Air Scrubber Mobile by Aerus to the consumer, subject to the conditions below, against defects in workmanship or material, provided that the products are returned to a service location within the following time periods:

- Air Scrubber Mobile by Aerus within one (1) year of date of purchase.

INSTALLATION AND MAINTENANCE REQUIREMENTS

This warranty is expressly conditioned upon proper installation, operation, cleaning and maintenance, all in accordance with the Owner's Manual. Failure to meet any of these requirements will void this warranty. Servicing of your Air Scrubber Mobile by Aerus by parties other than our authorized representative and/or using parts other than genuine parts will also void this warranty.

HOW TO OBTAIN WARRANTY SERVICE

Customer must contact Customer Service or their Independent HVAC Contractor and provide proof of purchase within the above time period. We will repair or replace and return the product, without charge and within a reasonable period of time, subject to the conditions in the above paragraphs, if its examination shall disclose any part to be defective in workmanship or material. If we, in our discretion, are unable to repair the product after a reasonable number of attempts, we will provide either a refund of the purchase price or a replacement unit, at the company's option.

WHAT IS NOT COVERED BY THIS WARRANTY

This product is intended for household use only. Ordinary wear and tear shall not be considered a defect in workmanship or material. These warranties do not apply to filters nor for loss or damage caused by accident, fire, abuse, misuse, improper installation, modification, misapplication, commercial use, or by any repairs other than those provided by our authorized Service Center.

MISSING SERIAL NUMBERS AND UNAUTHORIZED CHANNELS

If a valid serial number is missing from the product, the warranty will be voided. Our products are authorized for sale through our Independent HVAC Contractors only. Warranties are voided if a product is purchased through unauthorized channels, this includes websites that are not authorized to use our trademarked names, images and logos as well as Internet auction sites (e.g. ebay and Craigslist). The only approved Internet presence for our products is www.airscrubberbyaerus.com. To confirm warranty coverage prior to purchasing a product, contact Customer Service at 866.736.0503 with the serial number located on the back of the unit.

EXCLUSION OF OTHER WARRANTIES AND CONDITIONS

EXCEPT AS PROVIDED HEREIN, WE MAKE NO REPRESENTATION OR WARRANTY OF ANY KIND. ALL OTHER WARRANTIES OF ANY KIND, EXPRESS OR IMPLIED, ARE HEREBY EXPRESSLY DISCLAIMED, INCLUDING ANY IMPLIED WARRANTY OF MERCHANTABILITY OR FITNESS FOR A PARTICULAR PURPOSE.

LIMITATION OF LIABILITY FOR SPECIAL, INCIDENTAL, OR CONSEQUENTIAL DAMAGES

WE SHALL NOT IN ANY CASE BE LIABLE FOR SPECIAL, INCIDENTAL OR CONSEQUENTIAL DAMAGES ARISING FROM BREACH OF EXPRESSED OR IMPLIED WARRANTIES, CONDITIONS, GUARANTEES OR REPRESENTATIONS, BREACH OF CONTRACT, NEGLIGENCE OR ANY OTHER LEGAL THEORY. Such excluded damages include, but are not limited to, loss of profits or revenue, and loss of the use of the products.

FOR U.S. APPLICATION ONLY

This warranty gives you specific legal rights, and you may also have other rights which vary from state to state. Some states do not allow limitations on warranties, or on remedies for breach. In such states, the above limitations may not apply to you.

This warranty is provided by:
DBG Investments, LLC
300 East Valley Drive
Bristol, VA 24201.

SERVICE

Every effort is made to ensure customers receive an up-to-date instructions manual on the use of our products; however, from time to time, modifications to our products may without notice make the information contained herein subject to alteration. For the latest information, please visit our web site at www.airscrubberbyaerus.com.

This equipment has been tested and found to comply with the limits for Industrial, Scientific, and Medical Equipment (ISM), pursuant to Part 18 of the FCC Rules. These limits are designed to provide reasonable protection against harmful interference in a residential installation. This equipment generates, uses, and can radiate radio frequency energy, and if not installed and used in accordance with the instructions, may cause harmful interference to radio communications. However, there is no guarantee that interference will not occur in a particular installation. If this equipment does cause harmful interference to radio or television, which can be determined by turning the equipment off and on, the user is encouraged to try to correct the interference by one or more of the following measures:

- Reorient or relocate the receiving antenna
- Increase the separation between the equipment and receiver
- Connect the equipment into an outlet on a circuit different from that to which the receiver is connected
- Consult the Dealer or an experienced radio/ TV technician for help

FCC DECLARATION OF CONFORMITY

Name Air Scrubber Mobile by Aerus

Model A1018C

Manufacturer ... DBG Group Investments, LLC

This device complies with Part 18 of the FCC Rules.

RESPONSIBLE PARTY

DBG Group Investments, LLC

300 East Valley Drive

Bristol, VA 24201

Ph: 866.736.0503

Signature: 

Printed Name: Andy Eide

Title: Vice President of Product Development and Manufacturing

Date: 07/15/18

DBG Group Investments, LLC

300 East Valley Drive

Bristol, VA 24201